

# 415-58

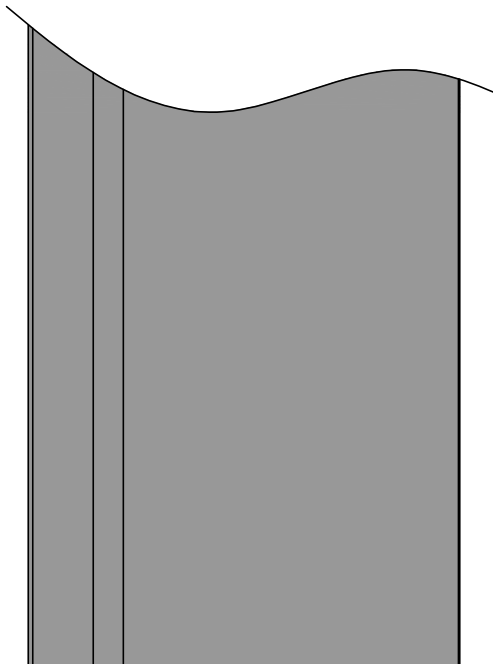
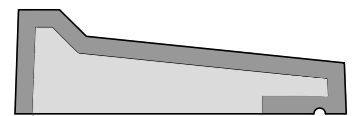
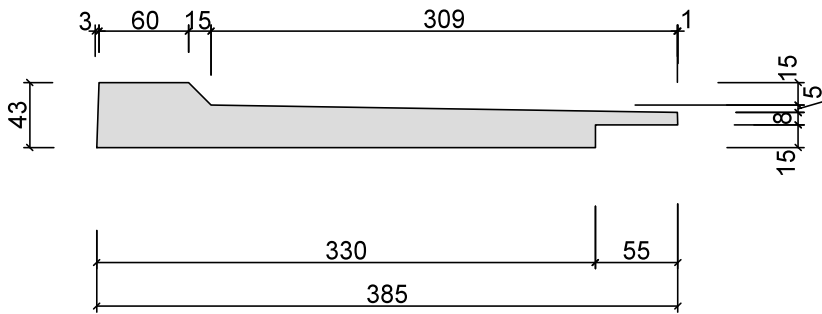
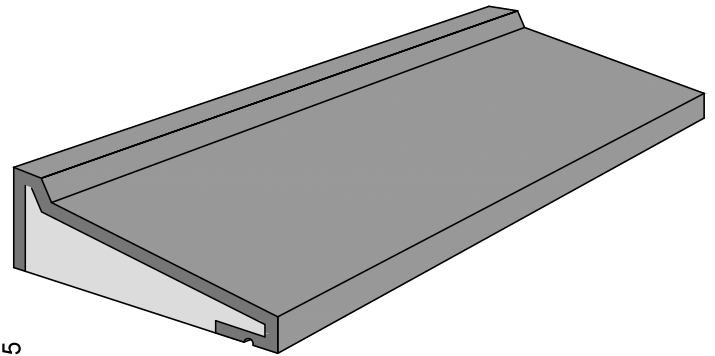
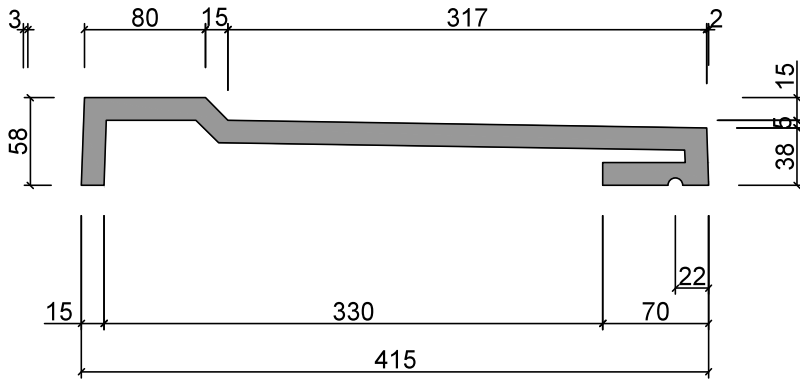

## Béton Fibré à Haute Performance

Fibres	Organique
Résistance en compression	90-130 MPa
Résistance en flexion	8-25 MPa
Densité	2,35
Porosité capillaire	1 à 1,4 %
Tenu au Gel / Dégel (sur 300 cycles)	100 %

### Isolant polystyrène expansé

Résistance à la compression	50 kPa
Conductivité thermique Vmax	38 mW/(m.K)
Masse volumique	14 kg/m <sup>3</sup>
Cohésion	90 kPa

### Performances thermique

Coefficient linéique	f = 0,35 W/(m.k)
----------------------	------------------

323 Chemin de Meurat  
74 540 CUSY  
04 50 32 68 10  
merillon@merillon.fr



Etude - Conception - Réalisation